

Product Manual: Ver 1.00

TP-440S-US

Takibi Tarp Hexa Set M



Thank you for purchasing a Snow Peak Product. This product is a tarp for camping. To use this product safely and correctly, please read these instructions carefully. After reading these instructions, keep this manual in a safe place for future reference. Although this product should be complete and safe, please check that all accessory items are included before attempting to assemble the product. Practice assembling and handling the product in a safe location prior to using in the field. If you find anything in the instruction manual that is difficult to understand, or if you find a product defect, stop use immediately and contact the dealers where you purchased the product, or Snow Peak Customer Service.

Safety Precautions Before use, please read thoroughly to ensure safety and to avoid accidents.

⚠ DANGER Misuse could easily result in a serious accident or death.

- Flame-retardant fabric is used for the inner roof of this product, but it is not non-combustible. Bringing the tarp too close to fire or heat sources may cause ignition, fire, or perforation. Please be sure to follow the below guidelines.
- This product is intended to be used for Takibi Fire & Grill (Snow Peak's original firepit) that has a total size of less than 47 x 47 x 40(H)cm including the pedestal. Do not use a firepit that is larger than the Takibi Fire and Grill.

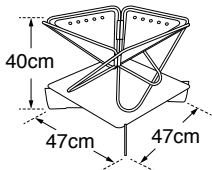

- The main body of the tarp is not flame retardant. Be sure to attach the inner roof to the main body when having a fire and place the fire stand in the position described in the figure below. Do not use multiple bonfires.

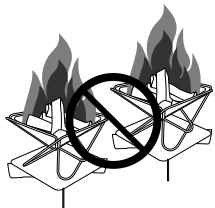
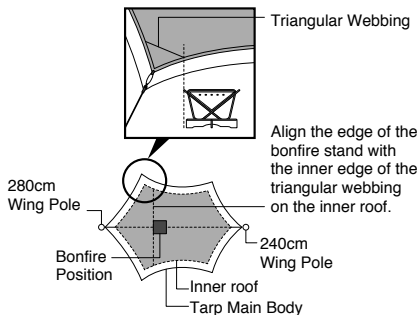

- Flames may create holes in the fabric of the inner roof if the bonfire is too large and close to the inner roof. Adjust the flame accordingly and keep it as least 1.2m away from the inner roof.

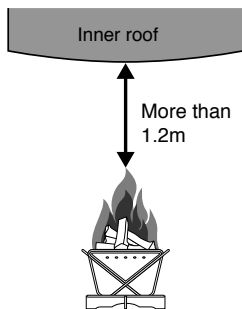

- The inner roof does not cover the entire tarp body. If the wind is strong and the flames fluctuate significantly outside the pit, stop the fire. Sparks may hit the main roof of the tarp and cause a hole or a fire.



- Do not set up the tarp on slanted ground. Sparks may penetrate the main tarp body which is not covered by the inner roof. Set up the tarp and bonfire on a flat surface.

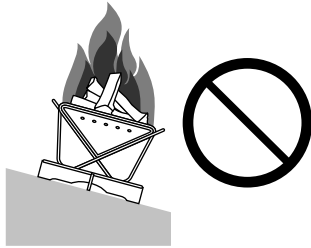

- Be sure to use a 280 cm and 240cm wing poles when burning a fire. If you use a short wing pole, the flame will be too close to the inner roof, which can cause fire or fabric damage.

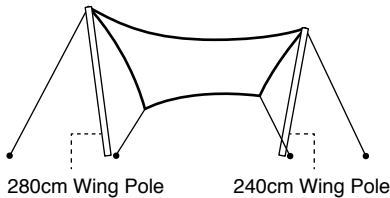

- The material of the tarp body is not flame retardant. Never have a campfire under the tarp without the inner roof. Keep the main part of the tarp away from heat sources such as combustion lanterns, stoves, heaters, open flames and small flames such as matches, candles, lighters, and cigarettes.

⚠ WARNING Misuse could result in serious injury to the user.

- Inspect the product to make sure that all parts are intact before use. If you find any abnormality, stop use immediately and contact your dealer or our user service for inspection or repair.
- Pay close attention to the weather. If extreme weather is forecast, pack up camp and evacuate to a safe place.
- The tarp has a large surface area and receives far greater wind pressure than you may realize. Regularly check to ensure the pegs and ropes are firmly installed during use. Do not use the tarp in strong winds.
- Pitch the tarp in a well-drained and flat area with firm ground. Choose an area where there is no chance of avalanches, landslides, wind gusts or sudden flooding.

⚠ CAUTION Misuse could result in injury to the user damage to property.

- This product is not intended to be permanently in use. If the tarp is left in the sun for long periods of time, the color may fade, and the fabric may deteriorate and lose strength.
- Sunlight can cause the surface of the tarp to heat up to the point of potentially causing low-temperature burns.
- Do not assemble or disassemble the tarp close to a bonfire, fireworks, etc. Flying sparks can create holes in the tarp fabric.
- Firmly hold the pole when assembling and disassembling the tarp. Unexpected accidents may occur due to the pole ends recoiling, etc, so ensure that the surroundings are safe, with no other people in the vicinity.
- Firmly fix the tarp to the ground using pegs and ropes.
- Since the tarp fabric is thin, it can be damaged if pulled too much. Please be careful.
- Be careful of the ropes and pegs when walking near the tarp. You may catch your foot, which may result in an unexpected accident.

Before Use

●While we guarantee this product has been thoroughly checked for quality, please do a trial setup of the product before actual use to learn the correct usage of the accessories and set-up procedures. If any defects are found, please contact the dealer where the product was purchased or Snow Peak Customer Service.

●This product does not come with hammer.

Wing pole x 2 and peg x 8 are required for basic setup. If you wish to use other poles and pegs than those included in the set, please refer to the recommended size below.

Recommended Pole/Peg Size

280cm Wing Pole x 1 pc

240cm Wing Pole x 1 pc

Peg with a length of 25cm or more x 8pcs (for the ropes at each corner)

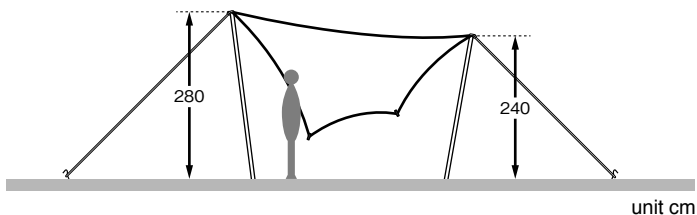

Set Contents

The contents are based on the setup requirements in general conditions. Please refer to the recommended size below. We also recommend carrying spare pegs and ropes.

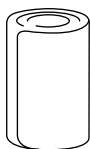

Tarp Main Body



Inner roof



Roof Sheet Tapes
(Red x 1, Black x 1)

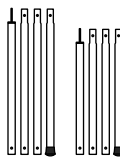

Wing Poles
(280cm, 240cm)



Steel Pegs (30cm x 8)

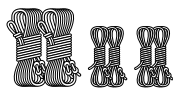

Ropes with Rope Tensioner
(Forked 10m x 2, 3m x 2, 2m x 2)

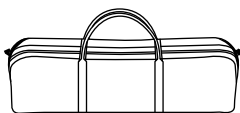

Carry Bag x 1



Pole Case
x 1



Peg Case
x 1



Instruction Manual
x 1

Peg Down Position of Rope with Rope Tensioner

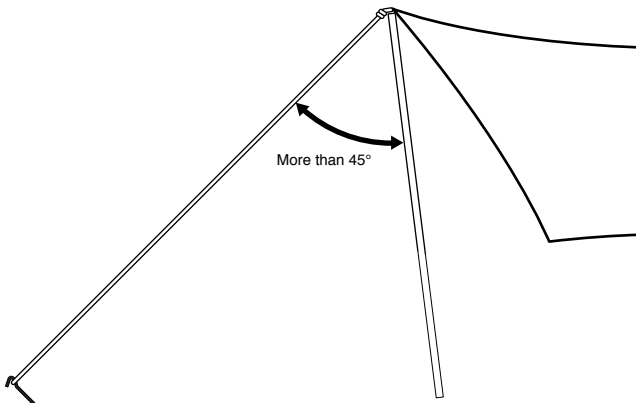
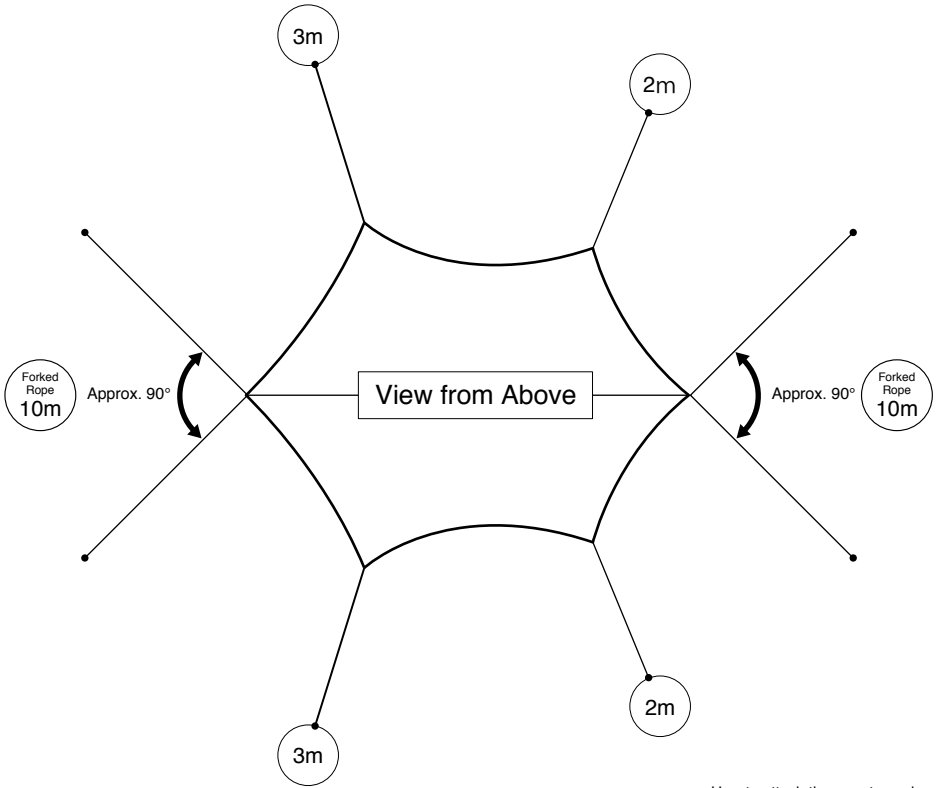

How to attach the rope to each corner

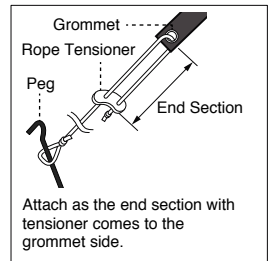

Peg Down Angle

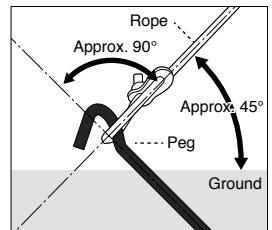

Set Up Procedure Make sure that two or more people take part in the set-up for safety.

Follow the instructions below for setup and removal so you're prepared to use the tarp in camp. Ensure all the accessories are included in the package. Forcible installation or removal may result in damage to the main unit or frames, or an accident. Please read thoroughly to understand the instructions.

1 Spread the tarp on the ground.

Lay the tarp out in a folded state on the flat place where setup will take place (see figure below). Set up the tarp while considering the wind direction and layout. At this time, the wing pole should also be placed with its tip on the tarp side, aligned with the ridgeline of the tarp. Place a 280 cm wing pole on the side with the red tape and a 240 cm wing pole on the side with the black tape.

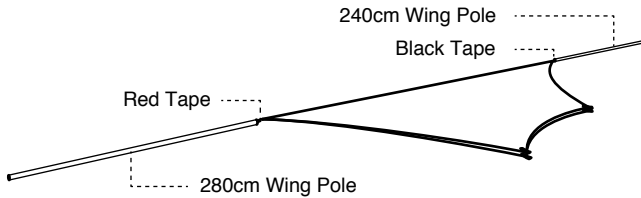

2 Attach the roof sheet tape and the triangle bracket of the tarp to the wing pole.

Insert the tip of the wing pole in the order of the roof sheet tape grommet and the triangle bracket.

* Make sure that the roof sheet tape (red/black) and the triangle bracket tape (red/black) match in color.

⚠ Note

Before installation, make sure the roof sheet tape is not frayed or deteriorated.

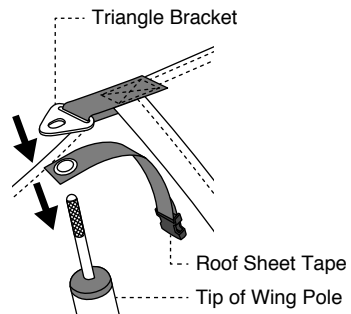

3 Attach the rope.

Insert the tip of the wing pole into the triangle bracket at the main corner, and hang a center loop of the forked 10m rope from above. (2 positions) After that, extend the rope toward the wing pole by 45° and extend the end of the rope to the position where the lower end of the wing pole is aligned, then peg down the end section.

How to attach the ropes at main corner.

Hang the center loop to the tip of the wing pole, then twist it once, and hang it again.

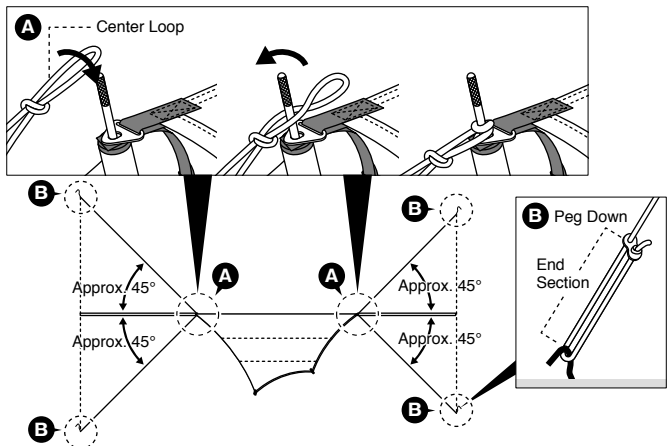

4 Set up the wing poles.

After loosening each rope once, stand the wing poles one by one so that the lower ends come under the fold of the tarp. Then adjust the rope tensioner of the forked rope and apply tension to make the tarp stand alone. Complete this step with 2 people; one should raise the wing pole, while the other adjusts the length of the rope.

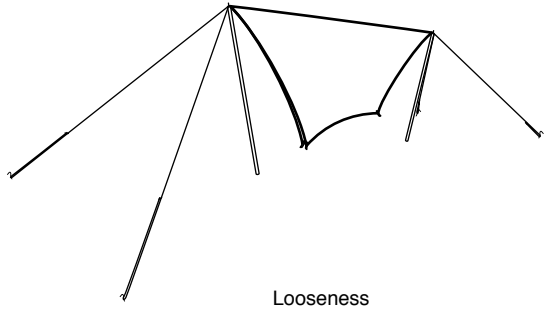

5 Loosen the ridge of the tarp

Adjust the position of the tensioner on the 10m rope, loosening it by about 20%. This looseness creates a beautiful curve.

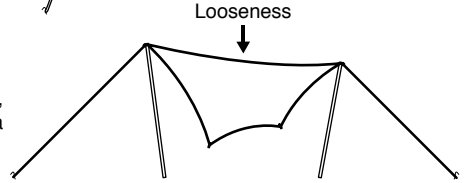

6 Attach the rope to each corner and secure it with a peg.

Follow the instruction "Peg Down Position of Rope with Rope Tensioner" on p.4. Pull the rope along the extension line that connects the corners of both wings from the center of the tarp (the extension line from the mounting direction with the tape and grommet at each corner).
※Be aware that if the rope is pulled in the wrong direction, it may cause wrinkles and prevent proper setup.

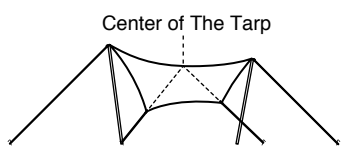
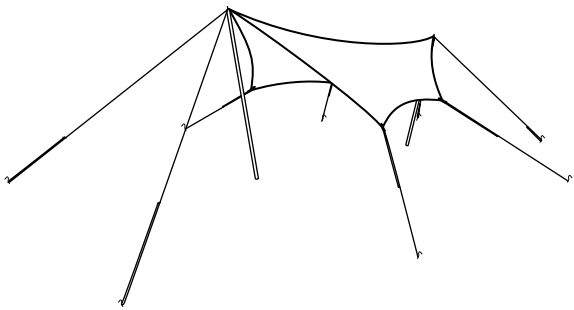

7 Adjust the tension of each rope.

Adjust the rope tensioner from the 3m and 2m ropes as shown right and apply tension. Pull each rope with equal force and apply tension on the forked rope after the looseness of the ridge has been removed. Finally, pull all the ropes one more time, as shown right.

※Be careful not to pull the rope too much. If you pull too hard, a large wrinkle will appear in that direction. Loosen the rope at the wrinkled corner and adjust the overall tension balance.

※If you use the tarp in a loose or wrinkled state, the tarp will be unstable and extremely dangerous as it could be hit by the wind and collapse, or the rain will accumulate causing potential damage and collapse.

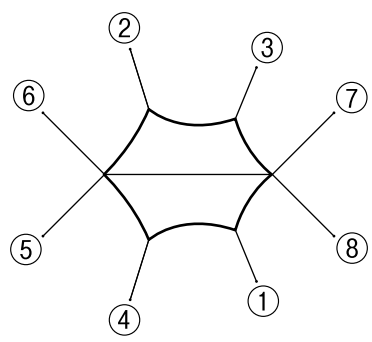

How to Attach The Inner Roof

The inner roof is made of flame-retardant material, but if not installed incorrectly, it may cause a fire.

1 Connect the buckles of the inner roof.

In order to reach the buckle of the tarp body, tilt the wing pole once and connect the buckle of the inner roof to the inside of the main corner. Connect the buckle to the side where you can see the end of the belt faces down (2 positions). After connecting, stand up the wing pole and readjust the tension with the adjustment belt on the inner roof

* Please work by tilting each wing pole. If you point a peg to the lower end of the wing pole, it will serve as a mark for rebuilding.

* Ensure the roof sheet tape (red/black) and the tape with the connecting buckle (red/black) match in color.

⚠ Attention

Be careful not to loosen or stretch the inner roof too much. If it is too loose, it will be very dangerous as it will be close to the bonfire. If it is too tight, the ridgeline of the tarp body will loosen and wrinkles will occur.

⚠ Attention

Be careful not to twist the belt with the connection buckle.

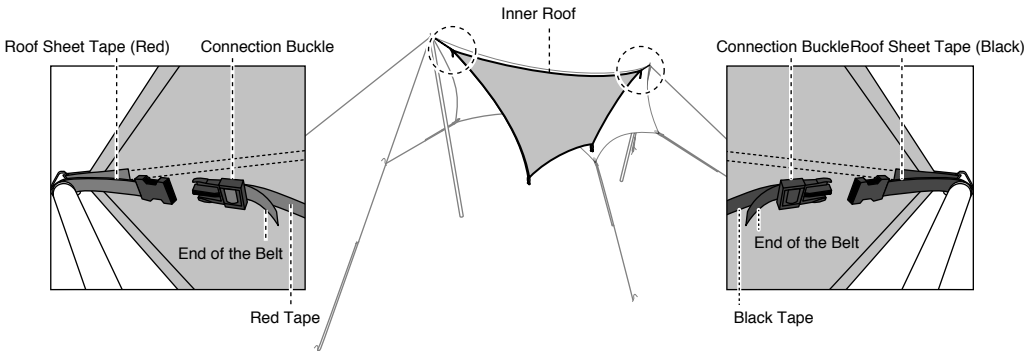

2 Connect each corner of the inner roof.

Hang the hook at each corner of inner roof to the ring at each corner of tarp. (4 positions)

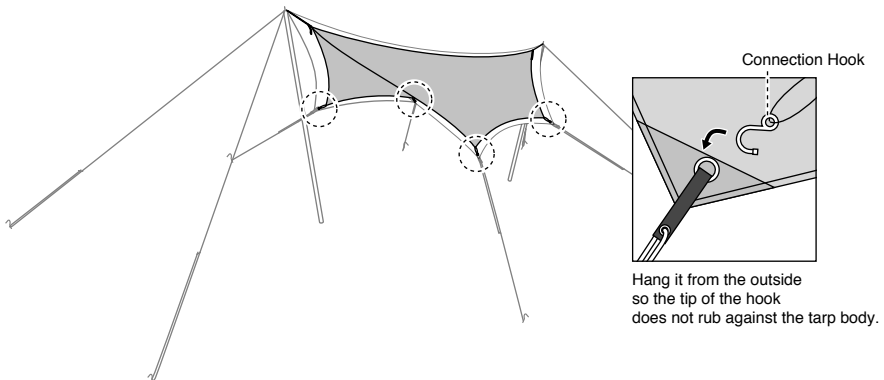

How to Disassemble Please be sure to disassemble with 2 or more people.

Make sure there is nothing under the tarp before disassembling.

If you are using a bonfire or a burner under the inner roof, be sure to move them after making sure putting out the fire and allowing it to cool. There should be plenty of distance between your gear and the tarp.

- ① If the inner roof is attached, remove the hook at each corner first and then remove the buckles. Tilt the wing pole once to reach the buckle. Stand up the wing poles again after the buckles are removed.
- ② Remove the rope pegs attached to each corner and remove the rope, except for the main corner of the tarp body.
- ③ Tilt the wing pole, remove the center loop of the forked rope, and then remove it from the roof sheet tape and tarp. We recommend reattaching the roof sheet tape to the inner roof and for easy storage.
- ④ Fold the tarp and inner roof into half, place them on the ground and fold the tarp according to the length of the carry bag, then place in the carry bag.

How to fold the tarp

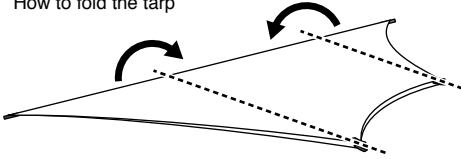

- ① Fold both ends inward to the corners as marked.

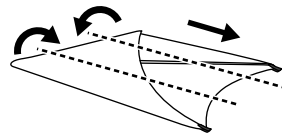

- ② Fold it in three vertically, then roll it in the direction of the arrow.

How to fold the inner roof

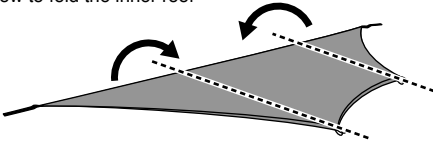

- ① Fold both ends inward to the corners as marks.

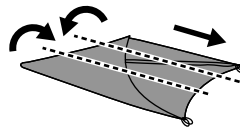

- ② Fold it in three vertically and roll it in the direction of the arrow.

- ⑤ Store the wing poles and pegs in the wing pole case and peg case. Leaving the poles or pegs outside of the case may damage the tarp/inner roof fabric.

※Please be careful not to leave pegs or ropes behind.

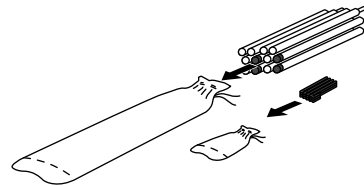

Precautions for Disassembling/Storage

- Please dry the tarp sufficiently before storing.
- Remove all pegs, clean off any dirt, and store in the peg case facing down. Please be careful not to lose or forget to remove any of the pegs.

First Aid

- As the fabric of the main body may be damaged due to an unexpected situation, please carry repair equipment such as gum tape or vinyl tape and take immediate measures as soon as possible. Leaving it damaged may cause it to break further or may not be repairable. Promptly remove items that are severely damaged.
- If the fabric is torn or if there is a hole in it, immediately attach it to both sides of the fabric with duct tape or remove it.

Water-Repellent and Water-Proof Functions

- The fabric of the tarp is treated with a high-quality, water-repellent finish. However, the level of water-repellent capacity and durability may vary slightly due to the characteristics of each material. In addition, the water repellency will deteriorate over long periods of time.
- The tarp is made of highly waterproof fabric, but if high water pressure is intensively applied from rain for a long period of time, water may seep in. Please be careful.

Regarding The Effect of Ultraviolet Rays

- UV protection is applied on the tarp fabric. The UV protection treatment will lessen the permeation of ultraviolet rays, which are harmful to humans, and slowdown the deterioration of the material.
- * The UV protection treatment does not completely prevent the influence of ultraviolet rays on humans or stop the deterioration of the strength of the material.
- When the tarp material is exposed to sun light for long periods of time, color degradation or deterioration of the fabric may occur. Do not leave the product assembled permanently.
- If the material deteriorates due to the influence of ultraviolet rays and is damaged, it may become irreparable.

About Polyester/Cotton Blend Fabric

- The inner roof is made of flame-retardant material, but it may be punctured or damaged depending on the usage and the environment. Please read the precautions in this manual carefully before using.
- If there's dirt such as smoke or soot, clean with a moistened cloth to remove the dirt.
- Compared to polyester fabric, the tarp's fabric that is more prone to mold, odors, and dirt due to likely exposure to water and moisture. Make sure the tarp is sufficiently dry before storing. Please store in a dry place away from the ground.

Maintenance/Storage

- Please ask our user service before using the product if it hasn't been used for a long time.
- Taking material characteristics into consideration, we adopted processing and color patterns that will result in less color migration. However, depending on storage conditions, a slight color migration may occur. Do not store the product while it is wet.
- Before storage, the product should be cleaned and dried sufficiently. If the product is stored when wet, the build-up of mold, bad odors, color migration and material deterioration will occur. Dry the product sufficiently in a breezy and shaded area, and clean the surface with a soft brush before storing.
- Clean and dry the surface of the poles before storing. If stored when wet, corrosion may occur, resulting in strength deterioration. Keep the joints clean and apply a small amount of silicone lubricant; applying excessive amount of lubricant will stain the tarp or carry case.
- Store the product in a breezy area, away from heat and moisture.
- Depending on the conditions of use, the tent material may deteriorate over a wide area and become irreparable and lose its durability.
- For long-term use of the tarp, regularly check and maintain it (including accessories such as the pegs).

Regarding Repair

- If professional repair is necessary, please contact the dealer where the product was purchased or Snow Peak Customer Service.
- Please dry and clean the product before sending it for repair.
- Please stick a memo onto the damaged area of the product for repair. Include details explaining the circumstances that led to the damage in the memo.
- Cost of the repair will be borne as follows:
 1. If the damage is subject to warranty, transportation cost (both ways) and repair cost will be paid by Snow Peak.
 2. If the damage is not subject to warranty, transportation cost (both ways) and repair cost will be paid by the customer.

Regarding Warranty

The specifications of Snow Peak products are based on field testing and quality control in order to ensure correct function and long-term use of the product. If apparent defects in the manufacturing of the product are found, the defective product will be repaired or exchanged free of charge. Damages as follows are not covered under warranty.

1. Material deterioration caused by age.
2. Damage caused by modifications or rough handling.
3. Damage caused by improper use not following the instruction manual.
4. Damage caused by unexpected accidents.
5. Damage not caused by defects in the manufacturing process.
6. Damage caused by dust or rust.
7. Damage or defects caused when dismantling the tent.
8. Damage and defects caused by dropping or other shocks to the tent and frames.
9. Change of parts due to friction and failure due to it
10. Damage caused by use of the product in combination with other maker's products.

Specifications

- Material: Tarp/210D Polyester Ox+PU coating with min.1800mm water resistant Teflon water repellent coating protection treatment, Inner Roof/ Polyester Cotton Mix
- Set Contents: Tarp, Inner Roof, Roof Sheet Tape (red, black), Wind Pole (280cm, 240cm), Steel Peg (30cm x 8), Rope with Rope Tensioner (Forked 10m x 2, 3mx 2, 2m x 2), Carry Bag, Pole Case, Peg Case
- Carry Bag Size: 000(h) cm
- Weight: 000kg

- Number of people
4 people

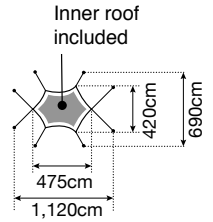
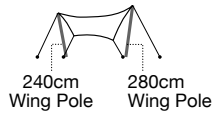

Snow Peak USA, Inc.

404 NW 23rd Ave., Portland, OR 97210, USA
Tel. +1-503-697-3330

www.snowpeak.com
Instagram @snowpeakusa

MADE IN CHINA